

**Please, read this manual
carefully before use!**

Owner's Manual



Electric lawn mower

KS 32LM12
KS 32LM12-BL
KS 38LM16
KS 38LM16-BL
KS 43LM20

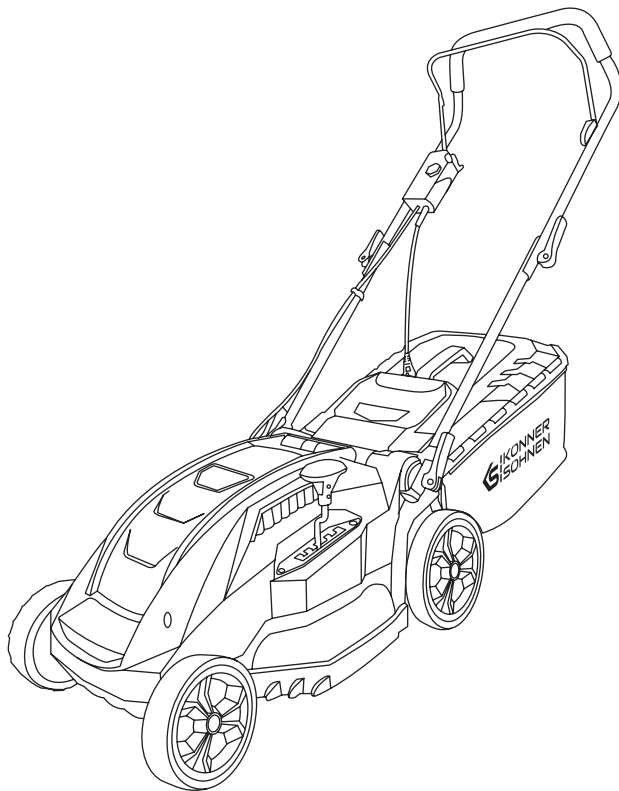



Thank you for opting for **Könnér & Söhnen®** products. This manual contains a brief description of safety, setup and use. More information can be found on the official importer's website in the support section: **konner-sohnen.com/pages/instructions**

You can also go to the support section and download the manual by scanning the QR code or on the website of the official importer of **Könnér & Söhnen®** at **www.konner-sohnen.com**



*Please, read this manual
carefully before use!*

The manufacturer of **Könnér & Söhnen®** products reserves the right to make changes that may not be reflected in this manual, namely:

- The manufacturer reserves the right to make changes in the product design, configuration and construction.
- The images and drawings in this manual are for reference only and may differ from the actual components and inscriptions on the products.

Contact information that you are free to use in case of any problems can be found at the end of this manual. All information in this manual is correct to the best of our knowledge and belief at the date of its publication. The current list of service centers can be found on the official importer's website at **www.konner-sohnen.com**



ATTENTION – DANGER!



Failure to follow the recommendations marked with this sign may lead to serious injury or death of the operator or third parties.



IMPORTANT!



Useful information while operating the machine.

IMPORTANT SAFETY INFORMATION

1



WARNING!



Read all instructions failure to follow all instructions listed below may result in electric shock, fire and /or serious injury.

WORK AREA

- Keep the work area clean and well lit. Cluttered and dark areas invite accidents.
- Do not operate power tools in explosive atmospheres, such as in the presence of flammable liquids, gases or dust. Power tools create sparks, which may ignite the dust or fumes.
- Keep children and bystanders away while operating a power tool. Distractions can cause you to lose control.

ELECTRICAL SAFETY

- Power tool plugs must match the outlet. Never modify the plug in any way. Do not use any adapter plugs with earthed (grounded) power tools. Unmodified plugs and matching outlets will reduce risk of electric shock.
- Avoid body contact with earthed or grounded surfaces such as pipes, radiators, ranges and refrigerators. There is an increased risk of electric shock if your body is earthed or grounded surfaces.
- Do not expose power tools to rain or wet conditions. Water entering a power tool will increase the risk of electric shock.
- Do not abuse the cord. Never use the cord for carrying, pulling or unplugging the power tool. Keep the cord away from heat, oil and sharp edges or moving parts. Damaged or entangled cords increase the risk of electric shock.

- When operating a power tool outdoors, use an extension cord suitable for outdoor use. Use of a cord suitable for outdoor use reduces the risk of electric shock.

PERSONAL SAFETY

- Stay alert. Watch what you are doing and use common sense when operating a power tool. Do not operate tool when you are tired or under the influence of drugs, alcohol or medication. A moment of inattention while operating power tools may result in serious personal injury.
- Use safety equipment. Always wear eye protection. Safety equipment such as dust mask, non-skid safety shoes, hard hat, or hearing protection used for appropriate conditions will reduce personal injuries.
- Avoid accidental starting. Ensure the switch is in the off position before plugging in. Carrying power tools with your finger on the switch or plugging in power tools that have the switch on invites accidents.
- Remove any adjusting key or wrench before turning the power tool on. A wrench or a key left attached to a rotating part of the power tool may result in personal injury.
- Do not overreach. Keep proper footing and balance at all times. This enables better control of the power tool in unexpected situations.
- Dress properly. Do not wear loose clothing or jewellery; Keep your hair, clothing and gloves away from moving parts. Loose clothes, jewellery or long hair can be caught in moving parts.

POWER TOOL USE AND CARE

- Do not force the tool. Use the correct power tool for your application, The correct power tools will do the job better and safer at the rate for which it was designed.
- Do not use the power tool if the switch does not turn it on and off. Any power tool that cannot be controlled with the switch is dangerous and must be repaired.
- Disconnect the plug from the power source before making any adjustments, changing accessories, or storing power tools. Such preventive safety measures reduce the risk of starting the power tool accidentally.
- Store idle power tools out of the reach of children and do not allow persons unfamiliar with the power tool or these instructions to operate the power tool. Power tools are dangerous in the hands of untrained users.
- Maintain power tools, Check for misalignment or binding of moving parts, breakage of parts and any other condition that may affect the power tools operation. If damaged, have the power tool repaired before use. Many accidents are caused by poorly maintained power tools.
- Keep cutting tools sharp and clean. Properly maintained cutting tools with sharp cutting edges are less likely to bind and are easier to control.
- Use the power tool, accessories and tool bits etc., in accordance with these instructions and in the manner intended for particular type of power tool, taking into account the working conditions and the work to be performed. Use of the power tool for operations different from intended could result in a hazardous situation.

SERVICE

- Have your power tool serviced by a qualified repair person using only identical replacement parts. This will ensure that the safety of the power tool is maintained.

ADDITIONAL SAFETY RULES FOR LAWN MOWER

2



WARNING!



Read the instructions carefully. Be familiar with the controls and the proper use of the appliance.

- Never allow children to use the appliance.
- Never allow people unfamiliar with these instructions to use the appliance. Local regulations may restrict the age of the operator.
- Keep bystanding people, children and animals out of the work area.
- The operator or user is responsible for accidents or hazards occurring to other people or their property.
- While operating the appliance, always wear substantial footwear and long trousers. Do not operate the appliance when barefoot or wearing open sandals.

- Thoroughly inspect the area where the appliance is to be used and remove all stones, sticks, wires, bones, and other foreign objects.
- Before using, always visually inspect to see that the rotating parts and cutter assembly are not worn or damaged. Replace worn or damaged parts in sets to preserve balance.
- Operate the appliance only in daylight or in good artificial light. Avoid operating the appliance in wet grass, where feasible. Always be sure of your balance on slopes. Walk, never run. Always work across the face of slopes, never up and down.
- Exercise extreme caution when reversing or pulling the appliance towards to you.
- Do not operate the appliance on excessively steep slopes.
- Switch the lawn mower off if appliance has to be tilted for transportation and when crossing surfaces other than grass, and when transporting the appliance to and from the working area.
- Never operate the appliance with defective guards or shields, or without safety devices, for example deflectors and/or catchers in place.
- Switch on the motor according to instructions and with feet well away from rotating parts.
- Do not tilt appliance when switching on the motor, expect if the appliance has to be tilted for starting. In this case, do not tilt it more than absolutely necessary and lift only the part, which is away from the operator. Always ensure that both hands are in the operating position before returning the appliance to the ground. Do not put hands or feet near or under rotating parts.
- Never pick up or carry an appliance while the motor is running.

Pull the plug from the socket:







- a). Whenever you leave the machine.
- b). Before clearing a blockage.
- c). After striking a foreign object. Inspect the appliance for damage and make repairs as necessary.
- d). If the appliance starts to vibrate abnormally, check immediately.







When the machine is at work in the thick bushes or runs into obstacles it can't cut down, the blade will be stalled so that the machine temperature and current will increase. When the temperature is too high or the current is too large, the overload protection device installed inside the machine will automatically shut off the power to stop the machine (main purpose is to protect motor and prolong motor life). At this moment, let go of the trigger and disconnect power supply of the machine, let the machine cool in some time (1-2 mins) and then restart switch, the machine can work again.

SYMBOLS

3

The rating plate on your tool may show symbols. These represent important information about the product or instructions on its use.

	Waste electrical products should not be disposed of with household waste. Please recycle where facilities exist. Check with your Local Authority or retailer for recycling advice.
	Denotes risk of personal injury, loss of life, or damage to the tool in case of non-observance.
	Wear sturdy, non-slip footwear.
	Read the user manual.
	Use protective gloves.
	Do not expose to rain.

	Keep children at a distance of no less than 10m from the work area.
	Beware of objects being thrown up keep a safe distance and keep other people away.
	This product is double insulated electrically
	Disconnect from mains power immediately if the power cord becomes damaged.
	Beware of sharp blades. Blades continue to rotate after the motor is switched off. Remove plug from mains before maintenance or if cord is damaged.
	Keep the electric cable away from the cutting tool

MAIN OVERVIEW

4



MODELS KS 32LM12, KS 32LM12-BL

1. Motor cover
2. Transport handle
3. Lower handle
4. Switch box
5. Upper handle
6. Grass collecting box
7. Wheels

MODELS KS 38LM16, KS 38LM16-BL, KS 43LM20

1. Height adjustment lever
2. Transport handle
3. Lower handle
4. Switch box
5. Switch handle
6. Upper handle
7. Grass collection bag
8. Wheels





IMPORTANT!



Manufacturer reserves the right to make changes and/or improvements in design, components set and technical attributes without notice and without incurring obligation. The pictures in this manual are schematical and may not match the parameters of original product.

SPECIFICATIONS

5

Model	KS 32LM12	KS 32LM12-BL	KS 38LM16	KS 38LM16-BL	KS 43LM20
Rated voltage	230V/50 Hz				
Rated power	1200 W	1200 W	1600 W	1600 W	2000 W
No-load speed	3450 rpm	3000 rpm	3200 rpm	3000 rpm	3200 rpm
Motor type	brush motor	induction	brush motor	induction	brush motor
Cutting capacity	320 mm	320 mm	380 mm	380 mm	430 mm
Adjustable height position	25–45–65 mm, 3 positions	25–45–65 mm, 3 positions	25–75 mm, 5 positions	25–75 mm, 5 positions	25–80 mm, 5 positions
Collection bag	30 l	30 l	40 l	40 l	50 l
Mulching function	–	–	+	+	+
Wheels	5.5"	5.5"	front 6.0", rear 8.0"	front 6.0", rear 8.0"	front 7.0", rear 10.0"
Gross dimensions (L×W×H)	590×380×290 mm		710×430×370 mm		720×470×366 mm
Gross/Net weight	7.7/6.5 kg	13/12 kg	14.5/13.2 kg	18/16.5 kg	15/13.75 kg

This tool is double insulated. There are two independent barriers of insulation to protect you from the possibility of electric shock.

NOISE DATA

Declared guaranteed sound power level: 96 dB (A).

The sound intensity level for operator may exceed 85 dB (A) and ear protection measures are necessary.

ASSEMBLY INSTRUCTIONS

6

MODELS KS 32LM12, KS 32LM12-BL

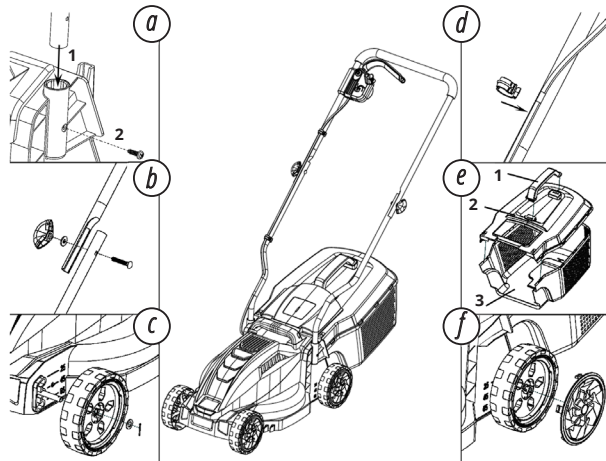

Fig. 1

1. Connect upper and lower handles with supplied screws (Fig. 1a).
2. Connect lower handles and the housing with supplied screws (Fig. 1b).
3. Fit each wheels over the axles and press the wheel covers into place (Fig. 1c, Fig. 1f).
4. Fix the cable holders (Fig. 1d).
5. Grass collection box assembly. Assemble three components and fix them together (Fig. 1e).

CUTTING HEIGHT ADJUSTMENT

To obtain the desired cutting height, the front and rear axles are repositioned on the underside of the mower housing.



WARNING!



Disconnect the mower from the power supply and ensure the blade has stopped coasting before adjusting the height.

1. To adjust the front wheel cutting height position (Fig. 2a):
 - 1). Turn the mower to its side.
 - 2). Pull the wheel axle towards the front of the mower.
 - 3). Locate the wheel axle into the desired cutting height adjustment position.



NOTE



Make sure that both front right and left wheels are located in the same cutting height adjustment position.

2. To adjust the rear wheel cutting height position (Fig. 2b):

Pull the rear wheel axle towards the mower's catcher cover.

Locate the wheel axle into the desire cutting height adjustment position.



NOTE



Make sure that both rear right and left wheel are located in the same cutting height adjustment position.

3. Cutting height positions (Fig. 2c):
 - 1). 25 mm (lowest cutting height position).
 - 2). 45 mm.
 - 3). 65 mm (highest cutting height position).

MODELS KS 38LM16, KS 38LM16-BL, KS 43LM20



NOTE



This models already have a mulching plug installed under the rear cover. Before using the lawnmower in grass collection mode, remove the plug.

Preparation:

1. Put the cable hook on upper handle, if available. (Fig. 3a).
2. Connect upper and lower handles with supplied screws and clips (Fig. 3b).
3. Connect lower handles and the housing with supplied screws and clips (Fig. 3c).
4. Fit each wheels over the axles and press the wheel covers into place (Fig. 3d, Fig. 3h).
5. Fix the cable holders (Fig. 3e).
6. Grass collection box assembly. Assemble three halves and fix them together (Fig. 3f).
7. Lift the cover and place the grass box over the lugs (Fig. 3g).

Fig. 2

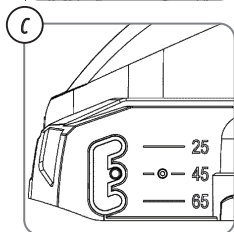
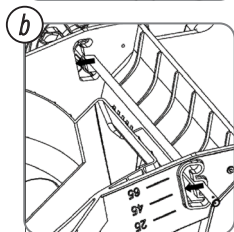
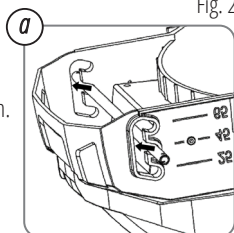

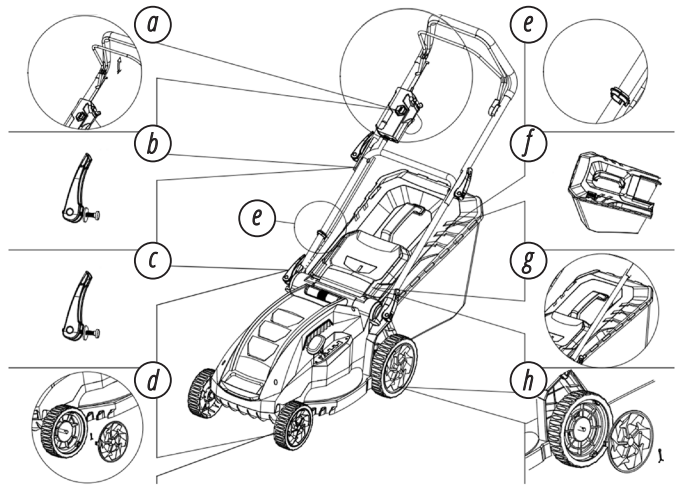

Fig. 3

CUTTING HEIGHT ADJUSTMENT



WARNING!



Disconnect the mower from the power supply and ensure the blade has stopped coasting before adjusting the height.

1. To raise the blade height, grasp the height adjustment lever and move it toward the back of mower (Fig. 4a).
2. To lower the blade height, grasp the height adjustment lever and move it toward the front of mower (Fig. 4b).

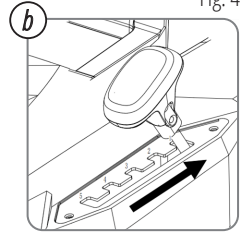
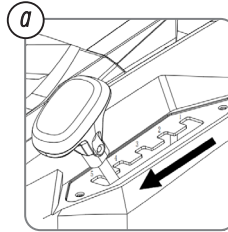

Fig. 4

OPERATING

7

CONNECT TO POWER SUPPLY



WARNING!



Before connecting to the mains supply, always check the switch is in off position. Connect the plug into the RCD protected power supply.

STARTING

ON/OFF switch (Fig. 5).

Caution! Do not start the mower if it is standing in long grass. Press the safety button (A) of the switch assembly and then pull the switch lever (B) against the bar. Hold down the switch lever while releasing the safety button.

To stop the mower release the switch lever and it automatically returns to off position.

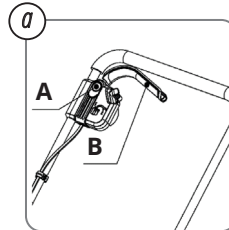

Models KS 32LM12,
KS 32LM12-BL

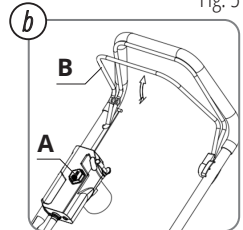

Models 38LM16,
KS 38LM16-BL, KS 43LM20

Fig. 5

MOWING (Fig. 6)

We recommend to use your mower as outlined in this section in order to achieve optimum results and to reduce the risk of cutting the mains cable.

- Place the bulk of the mains cable on the close to the starting point.
- Set the appropriate cutting height.
- Switch the mower on as described above.
- Proceed as shown in Fig. 6.
- Move from position 1 to position 2.
- Turn right and proceed towards position 3.
- Turn left and move towards position 4.
- Repeat the above procedures as required.

 **WARNING!**  **Do not work towards the cable.**

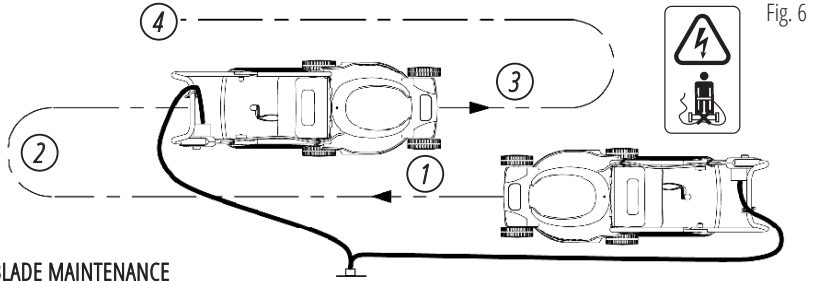

Fig. 6

BLADE MAINTENANCE

- Regularly remove grass and dirt from the blade.
- At the beginning of the gardening season, carefully examine the condition of the blade.
- If the blade is very blunt, sharpen or replace the blade.
- If the blade is damaged or worn, fit a new blade.

WARNING! Observe the following precautions:

- Disconnect the mower from the mains and wait until the blade has stopped rotating before proceeding.
- Be careful not to cut yourself. Use heavy-duty gloves or a cloth to grip the blade.
- Only use the specified replacement blade.
- Do not remove the impeller (A) for any reason (Fig 7).

TO REPLACE THE BLADE FOR MODELS KS 32LM12, KS 32LM12-BL (Fig. 7a):

- Turn the mower onto its side.
- Grip the blade (C) with one hand.
- Use the spanner supplied to loosen and remove the blade nut (B).
- Replace the blade.
- Securely tighten the blade nut.

TO REPLACE THE BLADE FOR MODELS KS 38LM16, KS 38LM16-BL, KS 43LM20 (Fig. 7b):

If the blade is slipping, put the screwdriver into the location hole, tighten the blade by wrench.

- Turn the mower onto its side.
- Place bushing into shaft of motor

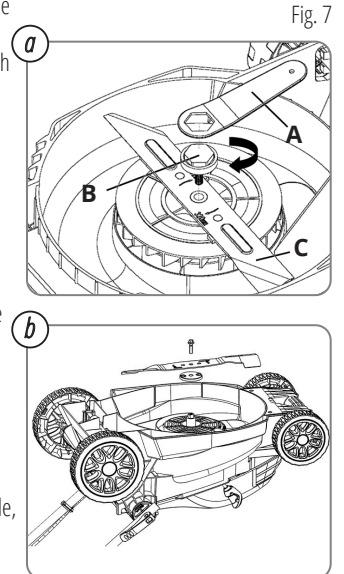

Fig. 7

- Place blade, flat pad and spring washer alignly.
- Place blade screw into the holes.
- Tighten blade screw with sleeve.

MULCHING FUNCTION FOR MODELS KS 38LM16, KS 38LM16-BL, KS 43LM20

Installing the Kit for mulching:

1. Open and hold the back cover and remove the grass collection box
2. Insert kit for mulching from above in ejection hole.
3. Close the cover.

MAINTANCE

8

1. Keep all nuts, bolts and screws tight to be sure the lawn mower is in a safe working condition.
2. Check the catcher frequently for wear or deterioration.
3. Replace worn or damaged parts for safety.
4. Only use the replacement blade, blade bolt and impeller specified for this product.
5. Be careful during adjustments of the lawn mower to prevent entrapment of the fingers between moving blade and fixed parts of the machine.
6. Oil the wheel pins.
7. Store the lawn mower in a dry place.

WARRANTY SERVICE TERMS

9

The international manufacturer warranty is 1 year. The warranty period starts from the date of purchase. In cases when warranty period is longer than 1 year according to local legislation please contact your local dealer. The Seller which sells the product is responsible for granting the warranty. Please contact the Seller for warranty. Within the warranty period, if the product fails because of defects in the production process, it will be exchanged on the same product or repaired.

All faults caused by the manufacturer during the warranty period will be eliminated free of charge. Warranty repair is carried out only if you have a fully completed warranty card, the Buyer's signature of acceptance of the warranty terms, as well as a document supporting the purchase (cash receipt, sales slip or invoice). In the absence thereof, as well as in the event of errors or corrections not authenticated by the seller's seal or illegible inscriptions in the warranty card or tear-off coupon, no warranty repair is carried out, no objections to quality are accepted and the warranty card is withdrawn by the service center as invalid. The device is accepted for repair clean and full.



EC Declaration of Conformity

Nr. 257

The following products have been tested by us with the listed standards and found in compliance with the European Community Machinery Directive 2006/42/EC, Electromagnetic compatibility Directive (EMC) 2014/30/EC, Noise Directive 2000/14/EC.

Manufacturer: DIMAX INTERNATIONAL GmbH
Address: Flinger Broich 203, 40235 Duesseldorf, Germany
Product: Electric lawn mower "Könnner & Söhnen"
Type / Model: KS 32LM12

The statement is based on a single evaluation of above mentioned products. It does not imply an assessment of the whole production and does not permit the use of the test lab. logo. The manufacturer should ensure that all product in series production are in conformity with the product sample detailed in this report. The applicant should hold the whole technical report at disposal of the competent all the right.

Applied EC Directives: 2006/42/EC Machinery Directive
2014/30/EC Electromagnetic compatibility Directive
2000/14/EC Noise Directive

Applied Standards: EN IEC 55014-1:2021
EN IEC 55014-2:2021
EN IEC 61000-3-2:2019/A1:2021
EN 61000-3-3:2013/A2:2021
EN 62841-1:2015/A11:2022
EN IEC 62841-4-3:2021/A11:2021

2000/14/EC_2005/88/EC Annex VI

For model KS 32LM12
Noise measured guaranteed Lwa = 96 dB (A).



Issued Date: 2025-11-18
Place of issue: Duesseldorf
Director: Fomin P.

P. Fomin

DIMAX
International GmbH
Flinger Broich 203 40235 Düsseldorf
USt-ID: DE296177274
koennner-soehnen.com

We DIMAX INTERNATIONAL GmbH hereby declare that specified above conforms covering European Parliament and Council Directives, 2006/42/EC of 17 May 2006 Machinery Directive, Electromagnetic compatibility Directive (EMC) 2014/30/EC of 26 February 2014, Noise Directive 2000/14/EC of 8 May 2000. The CE mark above can be used under the responsibility of manufacturer. After completion of an EC declaration of Conformity and compliance with all relevant EC directives.



EC Declaration of Conformity

Nr. 258

The following products have been tested by us with the listed standards and found in compliance with the European Community Machinery Directive 2006/42/EC, Electromagnetic compatibility Directive (EMC) 2014/30/EC, Noise Directive 2000/14/EC.

Manufacturer: DIMAX INTERNATIONAL GmbH
Address: Flinger Broich 203, 40235 Duesseldorf, Germany
Product: Electric lawn mower "Können & Söhnen"
Type / Model: KS 32LM12-BL

The statement is based on a single evaluation of above mentioned products. It does not imply an assessment of the whole production and does not permit the use of the test lab. logo. The manufacturer should ensure that all product in series production are in conformity with the product sample detailed in this report. The applicant should hold the whole technical report at disposal of the competent all the right.

Applied EC Directives: 2006/42/EC Machinery Directive
2014/30/EC Electromagnetic compatibility Directive
2000/14/EC Noise Directive

Applied Standards: EN IEC 55014-1:2021
EN IEC 61000-3-2:2019+A1:2021
EN 61000-3-3:2013+A1:2019+A2:2021
EN IEC 55014-2:2021
EN 62841-1:2015/A11:2022
EN IEC 62841-4-3:2021/A11:2021

2000/14/EC_2005/88/EC Annex VI

For model KS 32LM12-BL
Noise measured guaranteed $L_{wa} = 89$ dB (A).



Issued Date: 2025-11-18
Place of issue: Duesseldorf
Director: Fomin P.

P. Fomin

DIMAX
International GmbH
Flinger Broich 203 40235 Düsseldorf
USt-ID DE296177274
koenner-soehnen.com

We DIMAX INTERNATIONAL GmbH hereby declare that specified above conforms covering European Parliament and Council Directives, 2006/42/EC of 17 May 2006 Machinery Directive, Electromagnetic compatibility Directive (EMC) 2014/30/EC of 26 February 2014, Noise Directive 2000/14/EC of 8 May 2000. The CE mark above can be used under the responsibility of manufacturer. After completion of an EC declaration of Conformity and compliance with all relevant EC directives.



EC Declaration of Conformity

Nr. 259

The following products have been tested by us with the listed standards and found in compliance with the European Community Machinery Directive 2006/42/EC, Electromagnetic compatibility Directive (EMC) 2014/30/EC, Noise Directive 2000/14/EC.

Manufacturer: DIMAX INTERNATIONAL GmbH
Address: Flinger Broich 203, 40235 Duesseldorf, Germany
Product: Electric lawn mower "Könner & Söhnen"
Type / Model: KS 38LM16-BL

The statement is based on a single evaluation of above mentioned products. It does not imply an assessment of the whole production and does not permit the use of the test lab. logo. The manufacturer should ensure that all product in series production are in conformity with the product sample detailed in this report. The applicant should hold the whole technical report at disposal of the competent all the right.

Applied EC Directives: 2006/42/EC Machinery Directive
2014/30/EC Electromagnetic compatibility Directive
2000/14/EC Noise Directive

Applied Standards: EN IEC 55014-1:2021
EN IEC 55014-2:2021
EN IEC 61000-3-2:2019+A1:2021
EN 61000-3-3:2013/A2:2021
EN 62841-1:2015/A11:2022
EN IEC 62841-4-3:2021/A11:2021

2000/14/EC_2005/88/EC Annex VI

For model KS 38LM16-BL
Noise measured guaranteed $L_{wa} = 91$ dB (A).



Issued Date: 2025-11-18
Place of issue: Duesseldorf
Director: Fomin P.

P. Fomin

DIMAX
International GmbH
Flinger Broich 203 40235 Düsseldorf
USt-ID DE296177274
koenner-soehnen.com

We DIMAX INTERNATIONAL GmbH hereby declare that specified above conforms covering European Parliament and Council Directives, 2006/42/EC of 17 May 2006 Machinery Directive, Electromagnetic compatibility Directive (EMC) 2014/30/EC of 26 February 2014, Noise Directive 2000/14/EC of 8 May 2000. The CE mark above can be used under the responsibility of manufacturer. After completion of an EC declaration of Conformity and compliance with all relevant EC directives.



EC Declaration of Conformity

Nr. 260

The following products have been tested by us with the listed standards and found in compliance with the European Community Machinery Directive 2006/42/EC, Electromagnetic compatibility Directive (EMC) 2014/30/EC, Noise Directive 2000/14/EC.

Manufacturer: DIMAX INTERNATIONAL GmbH
Address: Flinger Broich 203, 40235 Duesseldorf, Germany
Product: Electric lawn mower "Könner & Söhnen"
Type / Model: KS 38LM16, KS 43LM20

The statement is based on a single evaluation of above mentioned products. It does not imply an assessment of the whole production and does not permit the use of the test lab. logo. The manufacturer should ensure that all product in series production are in conformity with the product sample detailed in this report. The applicant should hold the whole technical report at disposal of the competent all the right.

Applied EC Directives: 2006/42/EC Machinery Directive
2014/30/EC Electromagnetic compatibility Directive
2000/14/EC Noise Directive

Applied Standards: EN IEC 55014-1:2021
EN IEC 55014-2:2021
EN IEC 61000-3-2:2019/A2:2024
EN 61000-3-3:2013/A2:2021
EN 62841-1:2015/A11:2022
EN IEC 62841-4-3:2021/A11:2021

2000/14/EC_2005/88/EC Annex VI

For model KS 38LM16 Noise measured guaranteed $L_{wa} = 93$ dB (A).
For model KS 43LM20 Noise measured guaranteed $L_{wa} = 96$ dB (A).



Issued Date: 2025-11-18
Place of issue: Duesseldorf
Director: Fomin P.

P. Fomin

DIMAX
International GmbH
Flinger Broich 203 40235 Düsseldorf
USt-ID DE296177274
koenner-soehnen.com

We DIMAX INTERNATIONAL GmbH hereby declare that specified above conforms covering European Parliament and Council Directives, 2006/42/EC of 17 May 2006 Machinery Directive, Electromagnetic compatibility Directive (EMC) 2014/30/EC of 26 February 2014, Noise Directive 2000/14/EC of 8 May 2000. The CE mark above can be used under the responsibility of manufacturer. After completion of an EC declaration of Conformity and compliance with all relevant EC directives.

CONTACTS

Deutschland:

Hergestellt unter Lizenz und Kontrolle der DIMAX International GmbH.

Importeur und Vertreter in Deutschland:
DIMAX International GmbH, Flinger Broich 203,
40235 Düsseldorf, Deutschland. Produziert in VRC.
amazon@dimaxgroup.com
www.konner-sohnen.com

European Union:

Manufactured under license and control of DIMAX International GmbH, Flinger Broich 203, 40235 Duesseldorf, Germany.

Importer and representative in Netherlands DIMAX International Poland Ltd, Południowa 8 st,
05-830 Stara Wieś, Poland. Assembled in PRC.
amazon@dimaxgroup.com
www.konner-sohnen.com

The United Kingdom:

Innovation Trade Ltd., 5th Floor, 167-169 Great Portland Street, London, W1W 5PF, sales.uk@dimaxgroup.com

Technical support

support.uk@dimaxgroup.de
www.konner-sohnen.uk

France:

Fabriqué sous licence et contrôle de DIMAX International GmbH, Flinger Broich 203, 40235 Düsseldorf, Allemagne.

Importateur et représentant en France et en Belgique
DIMAX International Poland Ltd, Południowa 8 st,
05-830 Stara Wieś, Pologne. Assemblé en RPC.
amazon@dimaxgroup.com
www.konner-sohnen.fr

España:

Fabricado bajo licencia y control de DIMAX International GmbH, Flinger Broich 203, 40235 Düsseldorf, Alemania.

Importador y representante en España de DIMAX International Poland Ltd, Południowa 8 st,
05-830 Stara Wieś, Polonia.
Ensamblado en la República Popular China.
amazon@dimaxgroup.com
www.konner-sohnen.es

Polska:

Wyprodukowano na licencji i pod kontrolą DIMAX International GmbH, Flinger Broich 203,
40235 Duesseldorf, Niemcy.

Importer i przedstawiciel w Polsce:
DIMAX International Poland Sp.z o. o. ul. Południowa 8,
05-830 Stara Wieś, Polska. Zmontowany w CRL.
amazon@dimaxgroup.com
www.konner-sohnen.pl

Україна:

Виготовлено за ліцензією та під контролем DIMAX International GmbH, Flinger Broich 203,
40235 Дюссельдорф, Німеччина.

Імпортер та представник в Україні:
ТОВ "ТЕХНО ТРЕЙД КС" вул. Електротехнічна 47,
02225, м. Київ, Україна. Змонтовано в КНР
www.konner-sohnen.com.ua